

SR-SE Series

Energy Storage Battery

User Manual

V1.1

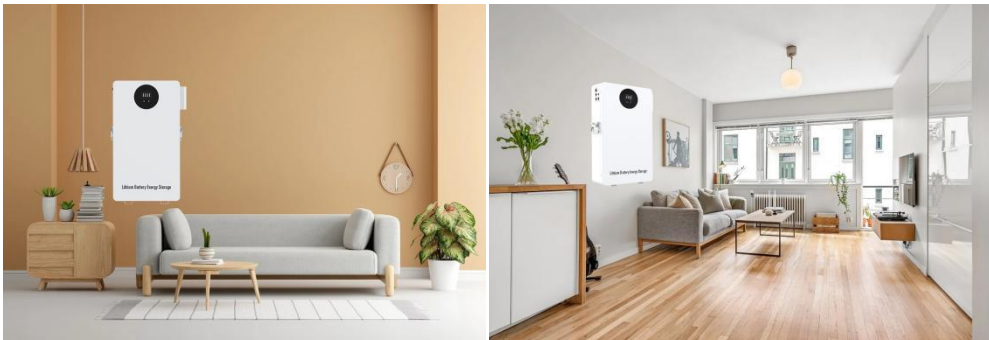

SR-SE05B

SR-SE10B

SR-SE15B

1. Instructions

Thank you very much for choosing the SE series household energy storage system developed and produced by our company. Please read and understand all contents of the Manual carefully before installing and using the product. If you have any suggestions during the use, please do not hesitate to give us feedback.

1.1 Range of Application

The installation and user manual of SR-SE series is applicable to the installation and use of the following products:

No	Model	Rated energy	Rated voltage
1	SR-SE05B	5.12kWh	51.2V
2	SR-SE10B	10.49kWh	51.2V
3	SR-SE15B	14.33kWh	51.2V

The product should be used in compliance with local standards, laws and regulations, because any non-compliance with the use may lead to personal injuries and property loss.

The drawings provided in this Manual are used to explain the concepts related to the product, including product information, installation guide, electrical connection, system debugging, safety information, common problems and maintenance, etc.

The internal parameters of this product have been adjusted before delivery. No internal parameters can be changed without permission. Any unauthorized changes to the settings will invalidate the warranty, and the Company will not be liable for any loss resulting therefrom.





This Manual and other related documents are an integral part of the product and should be kept properly for onsite installation personnel and related technical personnel to consult.

1.2 Meaning of Abbreviations

AC	Alternating Current
DC	Direct Current
PV	Photovoltaic
BMS	Battery Management System
PCS	Power Conversion System
RJ45	Registered Jack 45
SOC	State Of Charge
C	Charge C-rate
RS485	RS485 Communication Interface
CAN	Controller Area Network

1.3 Symbol Stipulations









There may be following symbols herein, and their meanings are as follows.

Symbols	Description
	Indicate a hazard with a high level of risk which, if not avoided, will result in death or serious injuries.
	Indicate a hazard with a medium level of risk which, if not avoided, could result in death or serious injuries.
	Indicate a hazard with a low level of risk which, if not avoided, could result in minor or moderate injuries.
	Warning information about device or environment safety. If not avoided, equipment damage, data loss, performance degradation or other unanticipated results may be resulted in. The "NOTICE" does not involve any personal injuries.

2 Safety Precautions

2.1 Safety Symbols

This product contains the following symbols, please pay attention to identifying.

Symbols	Description
	Observe enclosed documentation
	Danger. Risk of electric shock!
	Danger of high voltages. Danger to life due to high voltages in the Energy storage system
	Hot surface
	CE certification
	Do not touch the product in 5mins after shutdown
	Comply with RoHS standard
	The Energy storage system should not be disposed together with the household waste.

2.1 General Safety









2.1.1 Important Notice

Before installing, operating and maintaining the device, please read this Manual first and follow the symbols on the device and all the safety precautions in this Manual.

The matters indicated with "DANGER", "CAUTION", "ATTENTION" and "NOTICE" in this Manual do not represent all the safety matters to be observed, but are only the supplements to all the safety precautions. The Company will not be liable for any violation of general safety operating requirements, or any violation of safety standards for the design, production and use of the device. The device must be used in an environment that meets the requirements of the design specifications. Otherwise, the device may fail, and the abnormal device function or component damage, personal safety accident, and property loss arising from this are not covered within the quality assurance scope of the device. When installing, operating, and maintaining the device, the local laws, regulations, and codes shall be followed. The safety precautions in this Manual are only supplements to local laws, regulations, and codes. The Company shall not be liable for any of the following circumstances.

- The device is not run under the conditions of operating described in this Manual.
- The installation and operating environment is beyond the requirements of relevant international or national standards.
- The product is disassembled or changed, or the software code is modified without authorization.
- The operation instructions and safety warnings related with the product and in the documents are not followed.
- Damage of the device is caused by abnormal natural environment (force majeure, such as earthquake, fire, and storm).
- Transportation damage is caused during customer's own transportation.
- The storage condition does not meet the requirements of the product related documents and causes damage.

2.1.2 General Requirements

	<p>Operating when the power is on is strictly prohibited during installation.</p>
	<p>It is strictly prohibited to install, use, and operate any outdoor equipment or cables (including but not limited to transporting equipment, operating equipment and cables, plugging and removing signal ports connected to the outdoor, working at altitude, and outdoor installation) in severe weather, such as thunder, rain, snow, and gale level 6.</p>
	<p>In case of any fire, evacuate the building or equipment area and press the fire alarm bell or dial the fire call. Under any circumstances, re-entry into a burning building is strictly prohibited.</p>
	<p>Under no circumstances should the structure and installation sequence of the device be changed without the manufacturer's permission.</p>
	<p>The battery terminal components shall not be affected during transportation. And, the battery terminal bolts shall not be lifted or transported.</p>
	<p>It is strictly prohibited to alter, damage or block the marks and nameplates on the device.</p>
	<p>The composition and working principle of the entire photovoltaic power generation system, as well as the relevant standards of the country/region where the project is located shall be known fully.</p>
	<p>After the device is installed, the empty packing materials, such as cartons, foam, plastics, and cable ties, shall be removed from the device area.</p>

2.1.3 Personnel Safety

- When operating the device, appropriate personal protective equipment shall be worn. If any fault that may lead to personal injury or damage of the device is found, immediately terminate the operation, report to the responsible person, and take effective protective measures.
- Before using any tools, learn the correct method of using the tool to avoid injuries and damage of the device.
- When the device is running, the temperature of the case is high, which may cause burns. Therefore, do not touch the case.
- In order to ensure personal safety and normal use, reliable grounding should be carried out before use.
- Do not open or damage the battery. The electrolyte released is harmful to skin and eyes, so avoid touch it.
- Do not place irrelevant items on the top of the device or insert them into any part of the device.
- Do not place flammable items around the device.

- Never place the battery in the fire to avoid explosion and prevent the personal safety from being endangered.
- Do not place the battery module in water or other liquids.
- Do not short-circuit the battery terminals, because short-circuiting of the battery may cause combustion.
- The battery may pose a risk of causing electric shocks and large short-circuit currents. When using the battery, the following precautions should be paid attention to:
 - a) The metal objects, such as watch and rings, shall be removed.
 - b) Tools with insulated handles should be used.
 - c) Rubber gloves and shoes should be worn.
 - d) The charging power supply shall be disconnected before connecting or disconnecting terminals of the battery.
 - e) Check whether the battery is accidentally grounded. If the battery is accidentally grounded, remove the power supply from the ground.
- Do not clean the internal and external electrical components of the cabinet with water or detergent.
- Do not stand, lean or sit on the device.
- Do not damage any modules of the device.

2.2 Personnel Requirements

- The personnel in charge of installation and maintenance must be strictly trained to understand all safety precautions and master proper operation methods.
 - Only qualified professionals or trained personnel are allowed to install, operate and maintain the device.
 - The personnel who operate the device, including the operators, trained personnel and professionals, must have special operation qualifications required by the local country, such as high voltage operation, working high above the ground, and special equipment operation qualification.
- The replacement of device or components (including software) must be carried out by professionals or authorized personnel.

2.3 Electrical Safety

2.3.1 General Requirements



Before carrying out electrical connections, ensure that the device is not damaged, or an electric shock or fire may occur.



Never install or remove any power cables when the power is on. The electric arcs or sparks may be generated at the moment when the power cable contacts with the conductor, which may cause fire or personal injuries.

- All the electrical connections must meet the electrical standards of the country/region where the project is located.

- The cables prepared by users themselves shall comply with local laws and regulations.
- Special insulating tools should be used in high-voltage operations.
- Before connecting the power cord, ensure that the label identification on the power cord is correct.
- Operations on the device are allowed only five minutes after the device is completely powered off.
- The insulation layer of the cable may be aged or damaged when the cable is used in a high temperature environment. Therefore, the distance between the cable and the heat source must be at least 30mm.
- Cables of the same type should be bundled together. Whereas, the cables of different types should be routed at least 30mm apart, and shall not be wrapped together or crossed.

2.3.2 Grounding Requirements

- When installing the device to be grounded, the protective grounding wire must be installed first; when removing the device, the protective grounding wire must be removed at last.
- It is forbidden to destroy the grounding conductor.
- It is forbidden to operate the device without a grounding conductor installed.
- The device shall be permanently connected to the protective grounding wire. Before operating the device, electrical connection of the device shall be checked to ensure that the device is reliably grounded.

2.4 Installation Environment Requirements

- Do not install or use this product in an environment where the temperature is lower than -10 °C or higher than 50 °C.
- It should be installed in a dry and well-ventilated environment to ensure good heat dissipation performance.

- The product can be installed at a maximum altitude of 2,000m.
- The installation position should be away from the fire source.
- The product should be installed and used away from children and animals.
- The installation position should be far away from water sources, such as faucets, sewer pipes, and sprinklers, to avoid entering of water.
- The device should be placed on a firm and flat supporting surface.
- Do not place any inflammable or explosive items around the device.
- When the device is running, do not block the ventilation vent or heat dissipation system to prevent fire caused by high temperature.



The operation and service life of the energy storage is related to the operating temperature. The energy storage should be installed at a temperature equal to or better than the ambient temperature.



Max+50°C



Min-10°C



RH.+5%~+95%

3 Product Introduction

3.1 Battery Specifications

Product model	SR-SE05B	SR-SE10B	SR-SE15B
MAIN INFO			
Rated Voltage	51.2V		
Rated Capacity	100Ah	205Ah	280Ah
Battery Energy	5.12kWh	10.49kWh	14.33kWh
Battery Type	LFP		
Cycle Lifespan	6000 Cycles		
Max. Parallel Capacity	1 ~ 16 units		
CHARGE&DISCHARGE			
Max. Charging Voltage	57.6V		
Over Discharging Voltage	44.8V		
Standard charge/discharge current	50A	100A	140A
Max. charge/discharge current	100A	200A	200A
Peak. charge/discharge current	120A	240A	240A
GENERAL			
Weight	44kg	88kg	123kg
Dimension	399*646*150mm	436*690*256mm	837*380*253mm
Communication	CAN/RS485/USB		
WIFI	√		
Bluetooth	√		
Storage Condition	6 months @25°C;3 months @35°C;1 months @45°C		
Charging Temp. Range	0 ~ 45°C		
Discharging Temp. Range	-10 ~ 45°C		
Cooling Method	Natural cooling		
Protection Degree	IP30		
STANDARD			
Transportation	UN38.3,MSDS		
Safety	IEC 62619: 2017,EN IEC 61000-6		

3.2 Model Coding

The model coding of the energy storage battery is as follows:

SR-SE05B

① ② ③

Identifier	Meaning	Value
①	Product type	EOH: horizontally-mounted EOV: vertically-mounted SE: wall-mounted
②	Energy storage capacity level	05: The battery capacity is 5.12kWh 10: The battery capacity is 10.49kWh 15: The battery capacity is 14.33kWh
③	Product category	B: Energy storage battery C: Power conversion module S: Energy storage system

3.3 Appearance Description

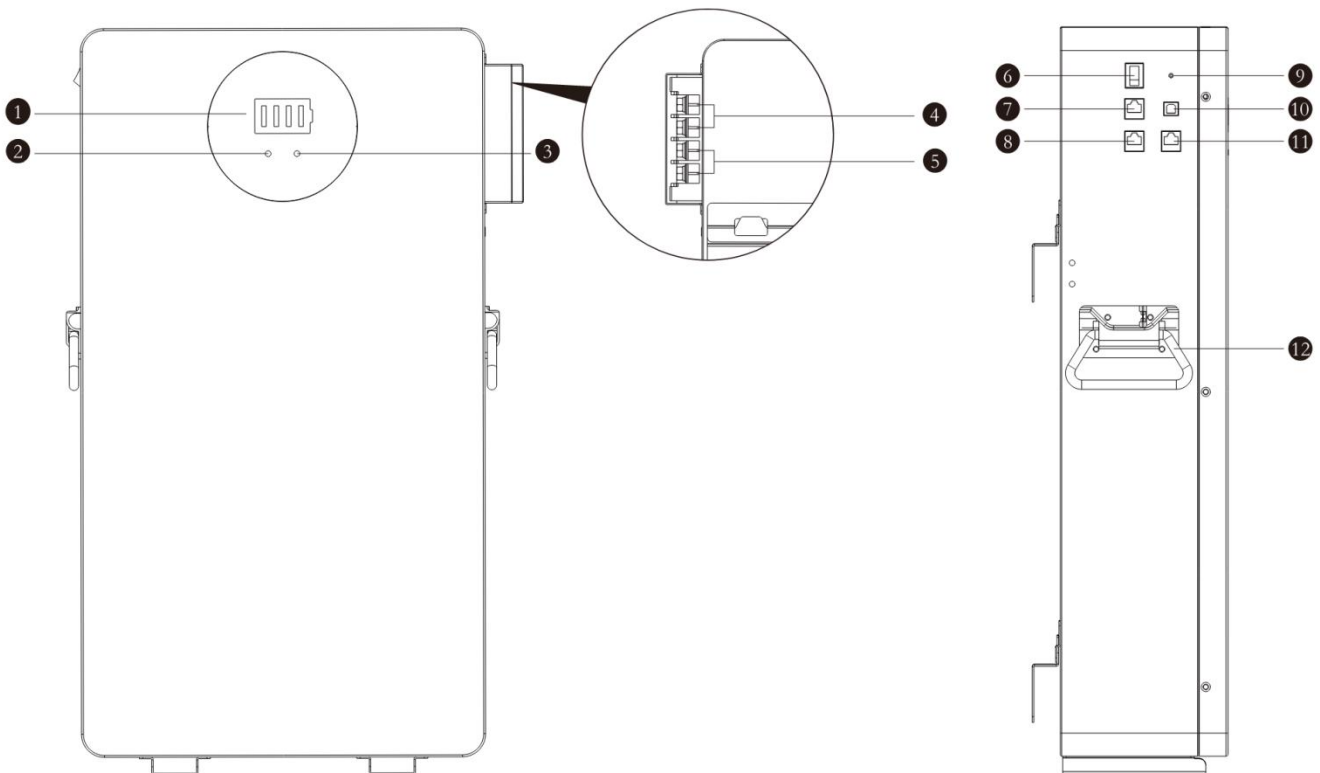

① SOC	② LED (COM)	③ LED (Fault)	④ Battery Negative
⑤ Battery Positive	⑥ Turn On/Off	⑦ BAT-OUT (connect other battery)	⑧ BAT-IN (connect other battery)
⑨ Reset	⑩ USB (Connect PC)	⑪ RS485/CAN (Connect inverter)	⑫ Handle

Communication interface definition

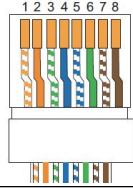
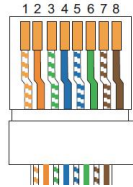
Number	Communication	Interface Type	Picture	instruction
⑦ ⑧	RS485	RJ45		1-RS485-B 2-RS485-A 7-RS485-A 8-RS485-B
⑪	RS485/CAN	RJ45		1-RS485-B 2-RS485-A 3-GND 4-CAN-H 5-CAN-L 6-GND 7-RS485-A 8-RS485-B

4 Application Scenarios

The lithium iron phosphate batteries with high performance and long service life are used in the energy storage module. Meanwhile, the modular structure design is adopted. Each energy storage module is internally integrated with the intelligent BMS system, which can be easily expanded and can be combined into 45Kwh battery pack at most.

The battery storage can be combined with SRNE brand inverter to form an on-grid or off-grid photovoltaic system, which can solve the problem of electricity consumption in areas without electricity.

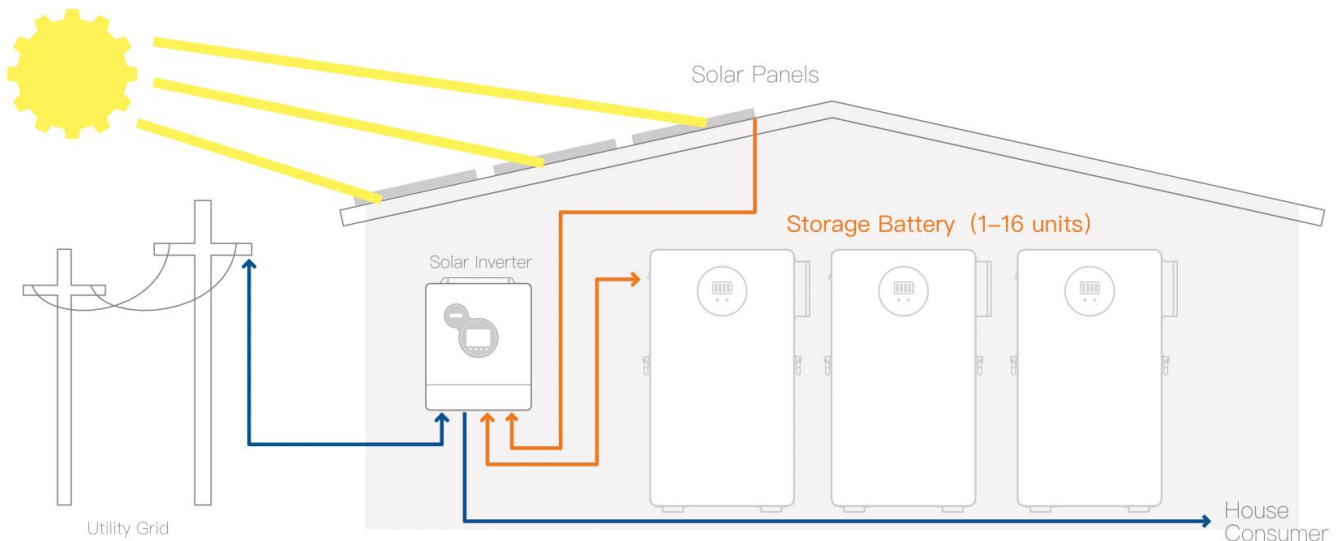

5 System Installation

5.1 Inspections before Installation

Inspection of outer package







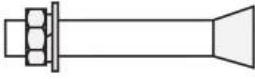
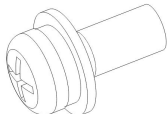
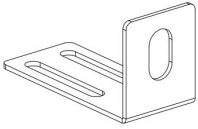
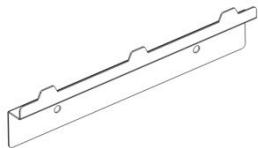
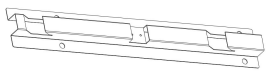
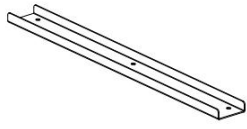
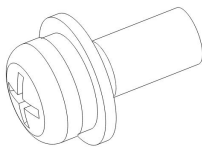



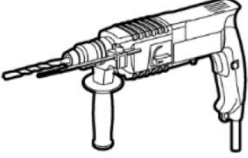

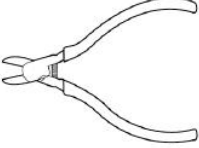
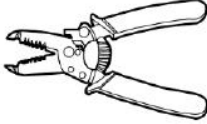
Before opening outer package of the energy storage, check if there is any visible damage on the outer package, such as holes, cracks or other signs of possible internal damage, and check the type of energy storage. If there is any abnormality on the package or model of the energy storage is inconsistent, do not open it and contact us as soon as possible.

Inspection of deliverables

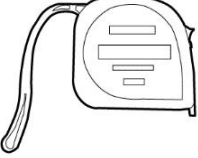
After opening outer package of the energy storage, check if the deliverable is complete and whether there is any visible external damage. If any items are missing or damaged, please contact us.

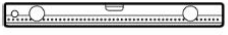
NO.	Picture	Item	Quantity	Specification
1		Battery Pack	1	5.12kWh/10.49kWh/14.33kWh
2		Mounting Frame Screw	8	M8*60 expansion bolt
3		Screw/Wrie	4	PM5*12mm
4		Side fastener	2	80*44*36mm
5		Side fastener (only for SE05B)	2	340*75.2*23mm
6		Mounting Frame (only for SE10/15B)	3	510.42*85.8*30mm
7		Mounting Frame Connecting Strip (only for SE10/15B)	1	375*39*12mm
8		Screw/Wrie (only for SE10/15B)	7	PM4*10mm

5.2 Preparation of Tools and Meters

Types	Tools and meters		
Installation tool			
			  
			
Personal protective equipment			
			

5.3 Selection of Installation Location

5.3.1 Basic Requirements

- When the energy storage is running, the temperature of the case and the radiator will be high. Therefore, do not install them in a place that is easy to touch.

- Do not install in areas where flammable and explosive materials are stored.

- If the energy storage is installed in areas with salt damage, it will be corroded and may cause fire.

Therefore, do not install it outdoors in areas with salt damage. The areas with salt damage are defined as the areas which are not 500m away from shore or will be affected by sea breezes. The areas affected by the sea breezes vary depending on meteorological conditions (e.g. typhoons, monsoons) or topographical conditions (dams, hills).

- Do not install in the place where children can touch.

- The energy storage cannot be installed forwardly, horizontally, inversely, backwardly or sideways.

- When drilling holes on walls or ground, the goggles and protective gloves shall be worn.

- During drilling, the device should be shielded to prevent debris from falling into the device. After drilling, the debris shall be cleaned up in time.
- When handling any heavy objects, you should be prepared to bear loads to avoid being crushed or sprained.
- When handling the device by hand, wear protective gloves to avoid injury.

5.3.2 Installation Space Requirements

Floor Mount: The battery should be placed in the right position first, and the installation site should be smooth and the wall should be solid, and the distance between the batteries should be greater than 200-350mm.

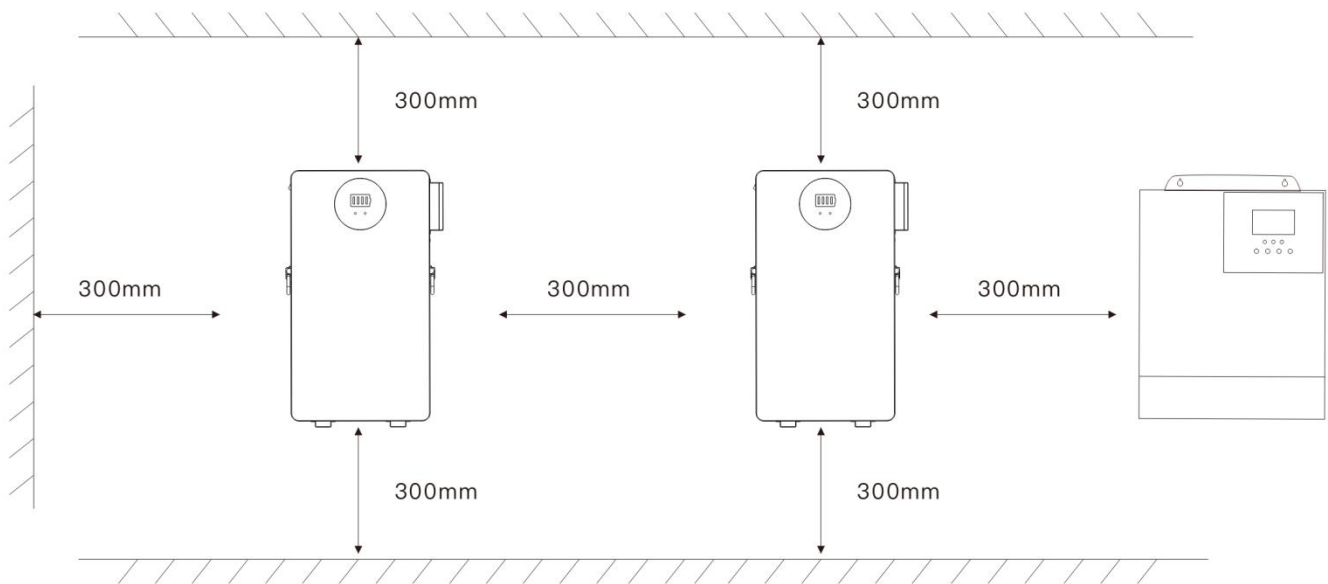

Wall mount: The battery should be placed in the right position first, and the installation site should be smooth and the wall should be solid, and the device is 300mm away from the ground, the distance between the batteries should be greater than 300mm.

5.4 Device Installation



In order to avoid electrical shock or other injury, inspect existing electronic or plumbing installations before drilling holes.



Choose suitable firm wall with thickness greater than 80mm.



The battery pack is very heavy, which requires multiple people to install.

5.4.1 SE05B Installation

5.4.1.1 Installation Location Selection

Drill 4 holes according to the hole position, it is $\phi 10$ with depth of 45~50mm. Hammer the M8 screws to the above holes, and screw the nut.

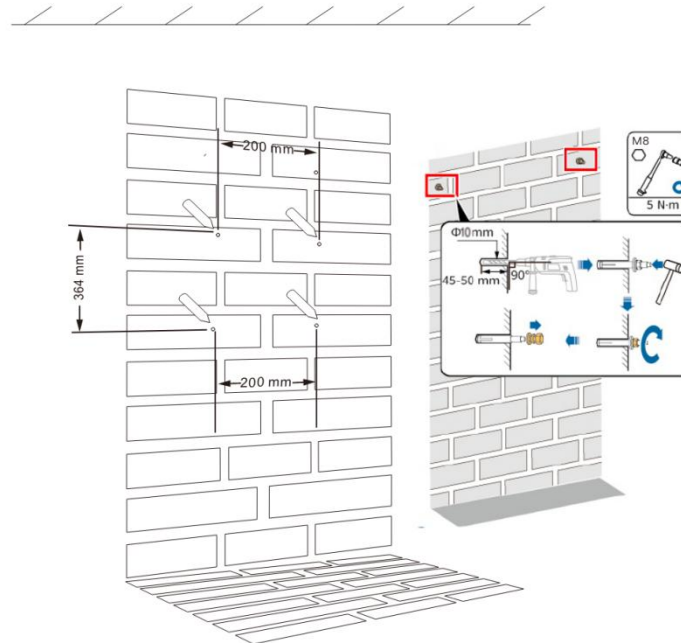

5.4.1.2 Install Battery Pack

Align the mounting bracket in the appropriate hole. Hammer the M8 screws into the above holes and screw on the nuts.

Hook the battery to the mounted bracket.

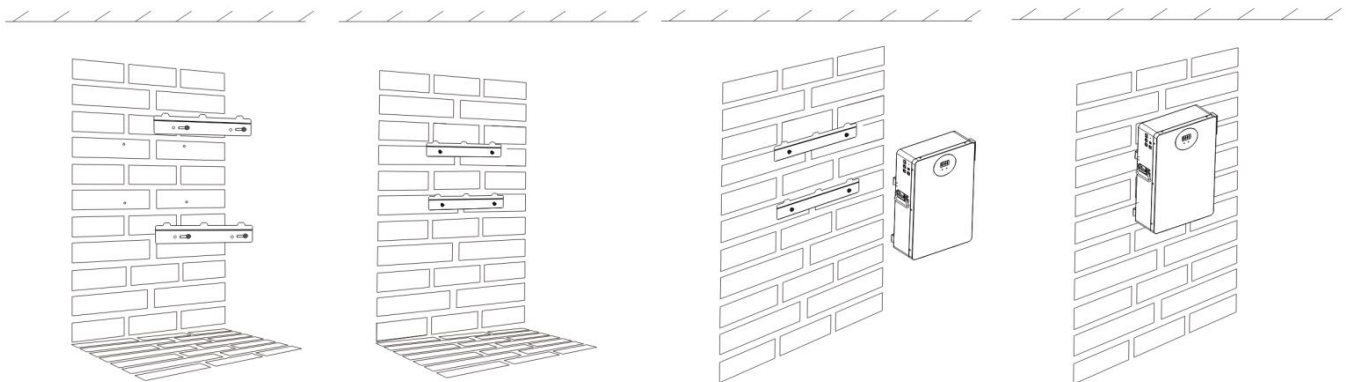

5.4.2 SE10B/SE15B Installation

5.4.2.1 Installation Location Selection

Drill 8 holes according to the hole position, it is $\phi 10$ with depth of 45~50mm. Hammer the M8 screws to the above holes, and screw the nut.

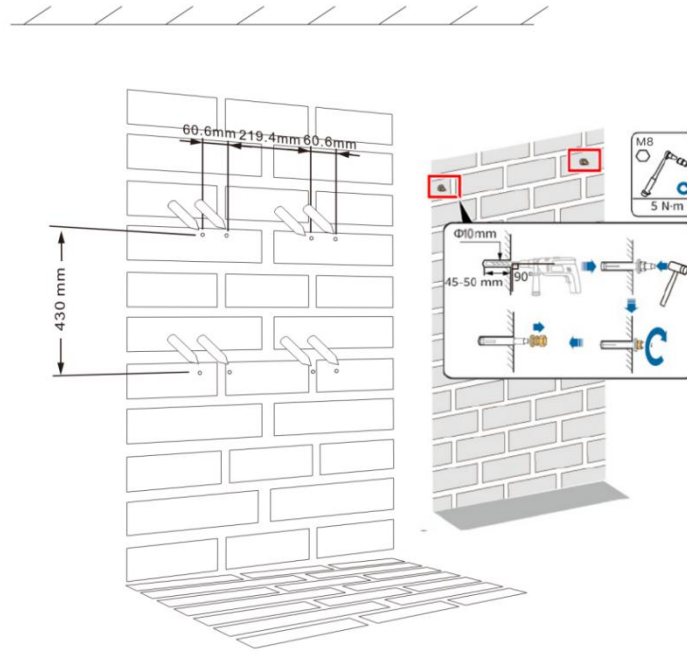

5.4.2.2 Fix Mounting Frame

Make the convex side outward and fix the mounting frame to the 8 screws.

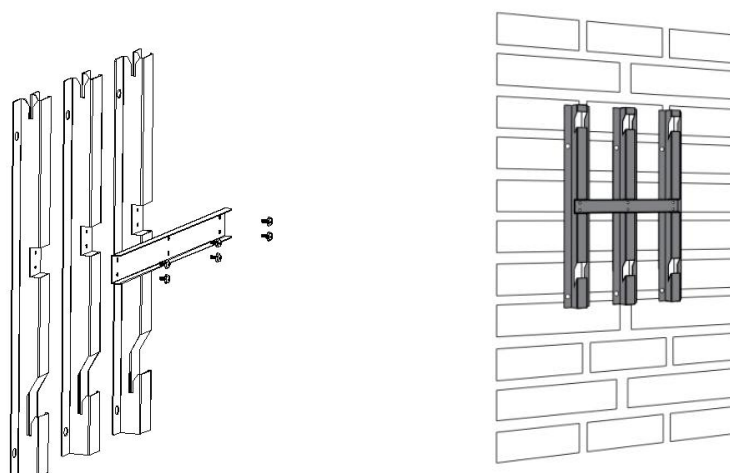

5.4.1.2 Install Battery Pack

Align the mounting bracket in the appropriate hole. Hammer the M8 screws into the above holes and screw on the nuts. Then hook the battery to the mounted bracket.

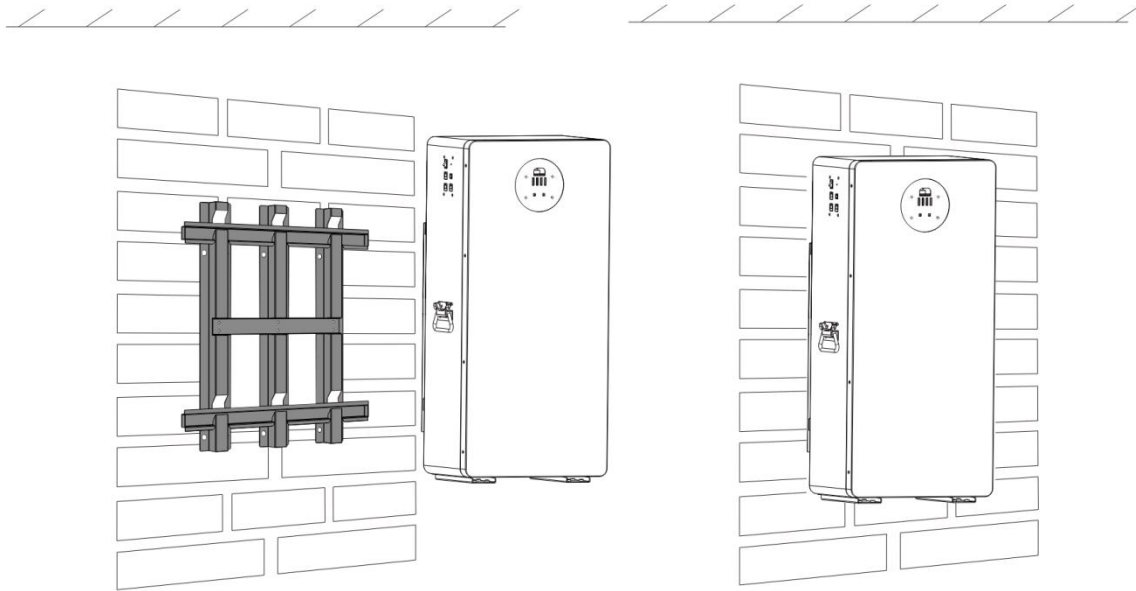

6 Electrical Connection





Before electrical connection, please ensure that the switches of the energy storage are in the "OFF" state. Otherwise, the high voltage of the device may cause electric shock.

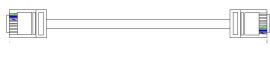

The operations related to electrical connections must be carried out by professional electrical technicians. When carrying out electrical connections, the operator must wear personal protective articles.

6.1 Preparation of Cables

No.	Cables	Description	Recommended specifications	Source
1		Power Cable	2	Standard
2		Signal cable	1	Standard
3		Ground cable between the storage battery modules	1	Prepare by the user itself

6.2 Electrical Connection Of One Battery Module

6.2.1 Connecting Power Cord

When connecting the battery wiring, please make sure that the battery switch is off and the indicator light is off, then remove the battery terminal cover plate and screws, prepare the appropriate power cable, crimp the terminal block, and then connect it to the battery.

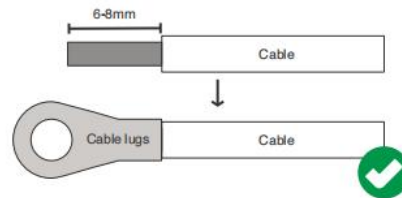

6.2.2 Connecting Grounding Wire

Each energy storage battery module shall be connected to the ground terminal supplied with the product.

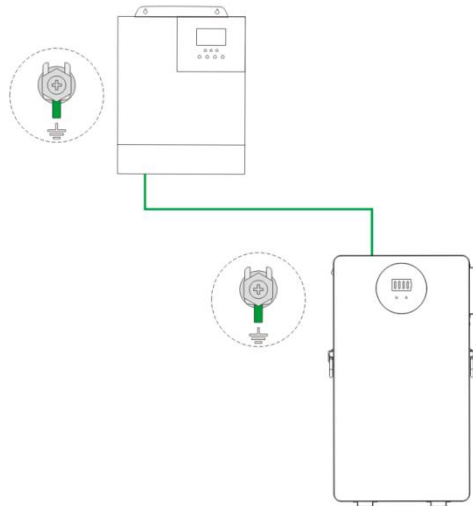

6.2.3 Connecting Power Cord

When connecting the battery wiring, please make sure that the battery switch is off and the indicator light is off.

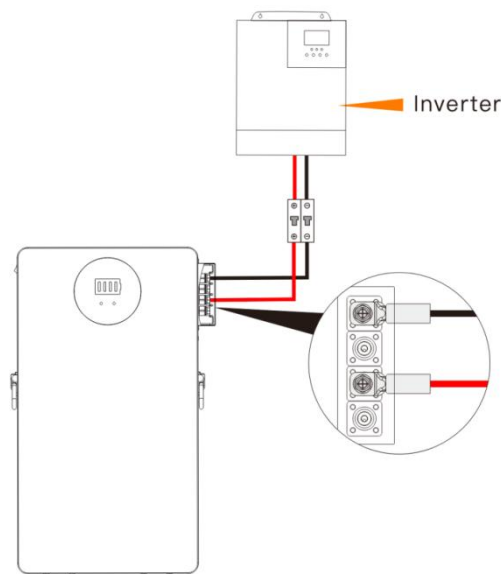

6.2.4 Connecting Signal Line

The signal line shall be used to connect RS485-Inverter interface for battery module and inverter.

The communication port of the SRNE brand inverter needs to be connected to the RS485-2 interface.

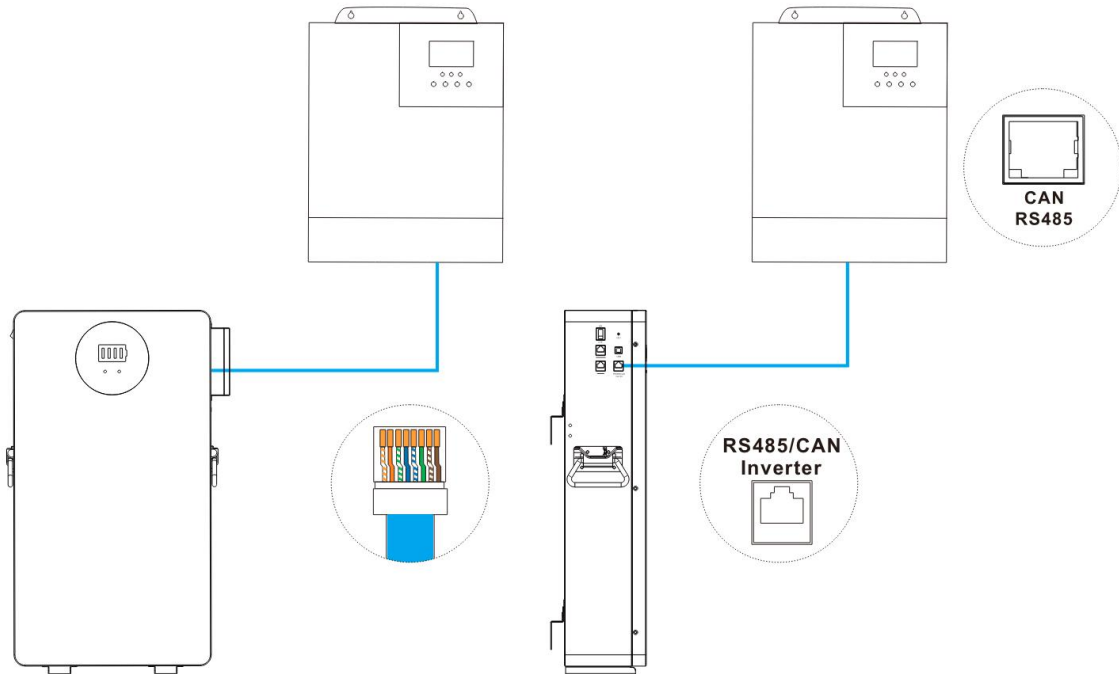

When connecting the inverter, the communication line must be connected and the communication protocol must be consistent.



The communication cable connected to the SRNE brand inverter is not a standard network cable. If you use a standard network cable, please cut off pins 1 and 2 for connection.

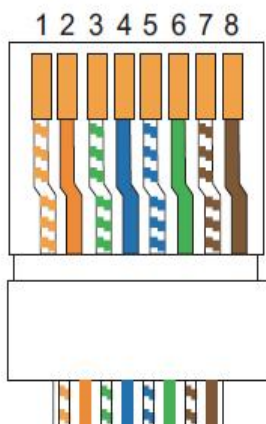

If you use a standard network cable to connect the inverter of the srne brand		
PIN1	White-orange	
PIN2	Orange	
PIN3	White-green	
PIN4	Blue	CAN-H
PIN5	White-blue	CAN-L
PIN6	Green	
PIN7	White-brown	RS485-A
PIN8	Brown	RS485-B

6.3 Electrical Connection Of Multiple Battery Modules

6.3.1 Connecting Grounding Wire

Each energy storage battery module should be connected to the ground terminal supplied with the product, or if there are multiple batteries, the earth wire for each battery needs to be connected.

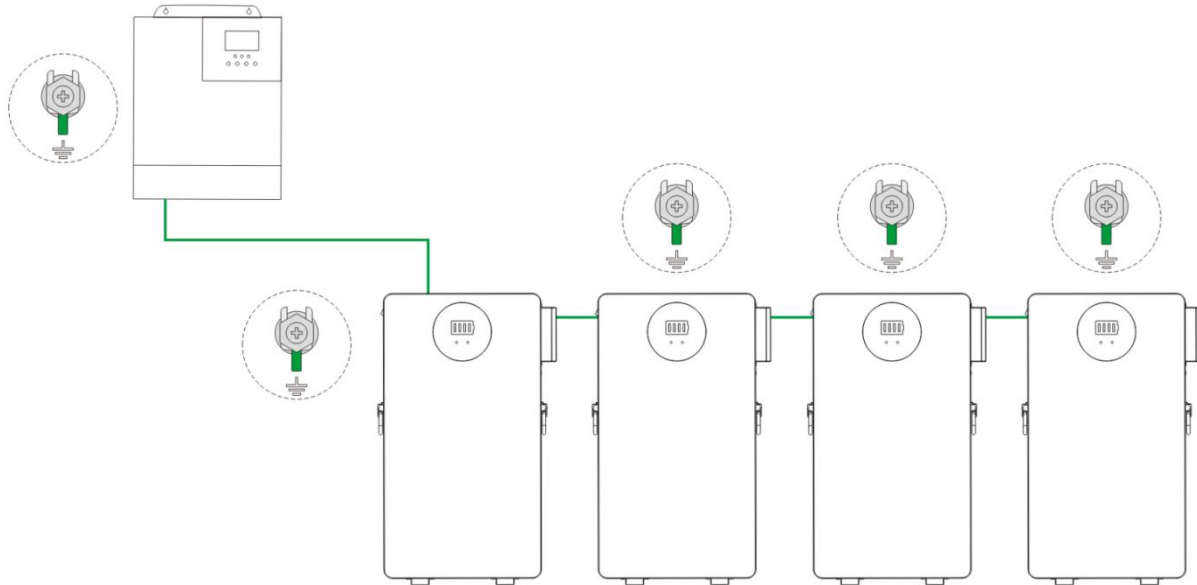

6.3.2 Connecting Power Cord

If there are 2 batteries used in parallel, you need to connect the power cord of each battery.

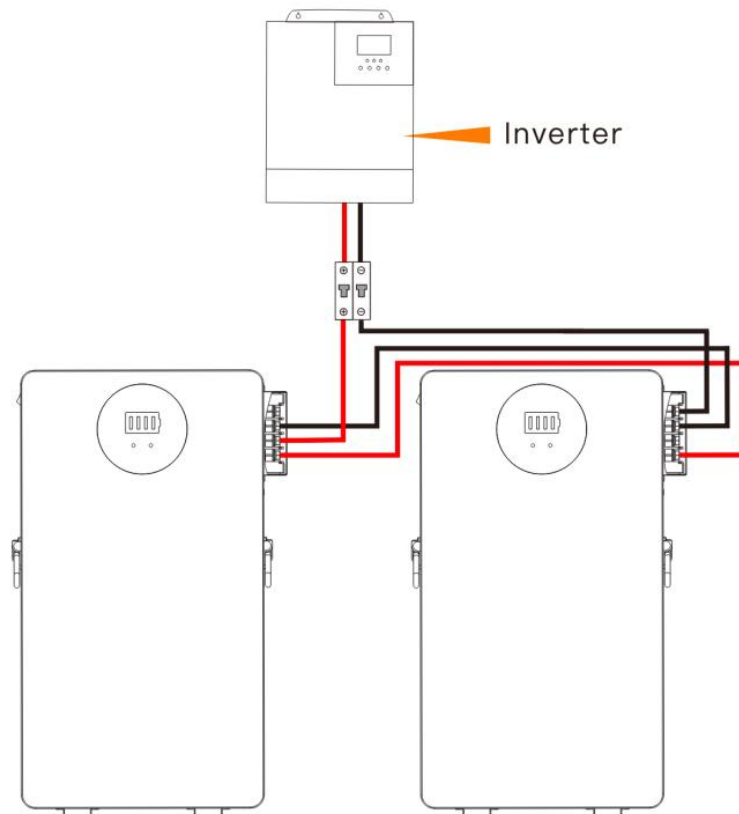

If multiple batteries are used in parallel, bus bar is required

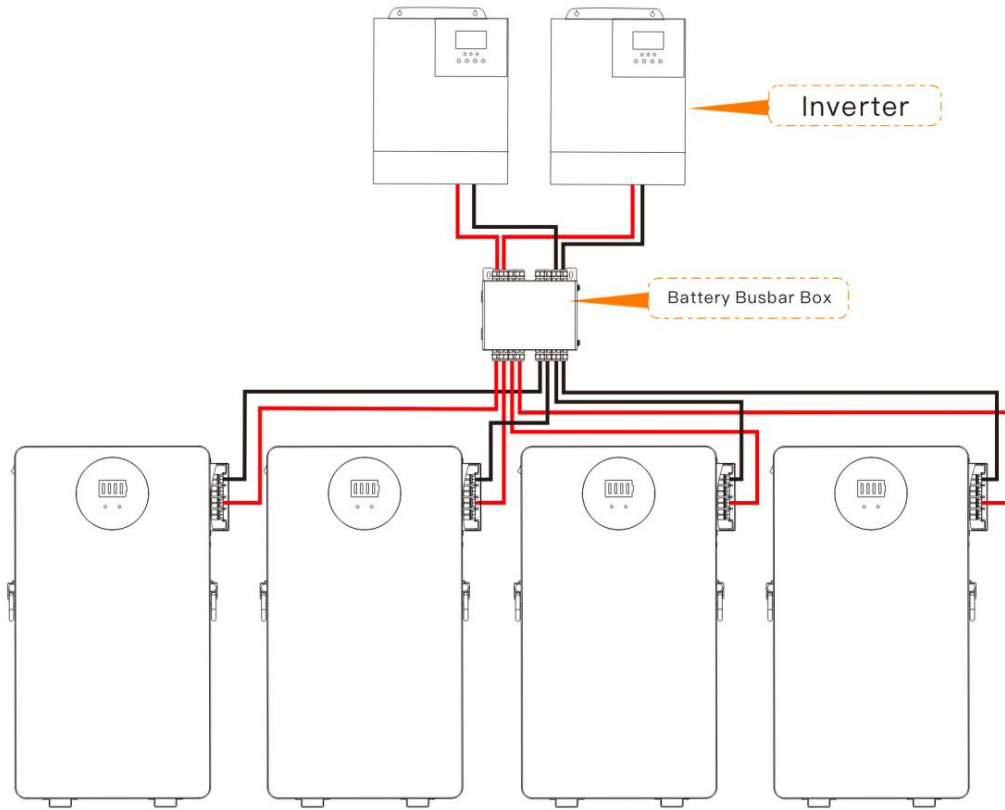

6.3.3 Connecting Signal Line

If there are multiple batteries, you need to connect the battery-to-battery connection uses the BAT-OUT connection to the BAT-IN battery interface, battery and inverter connection need RS485-Inverter interface.

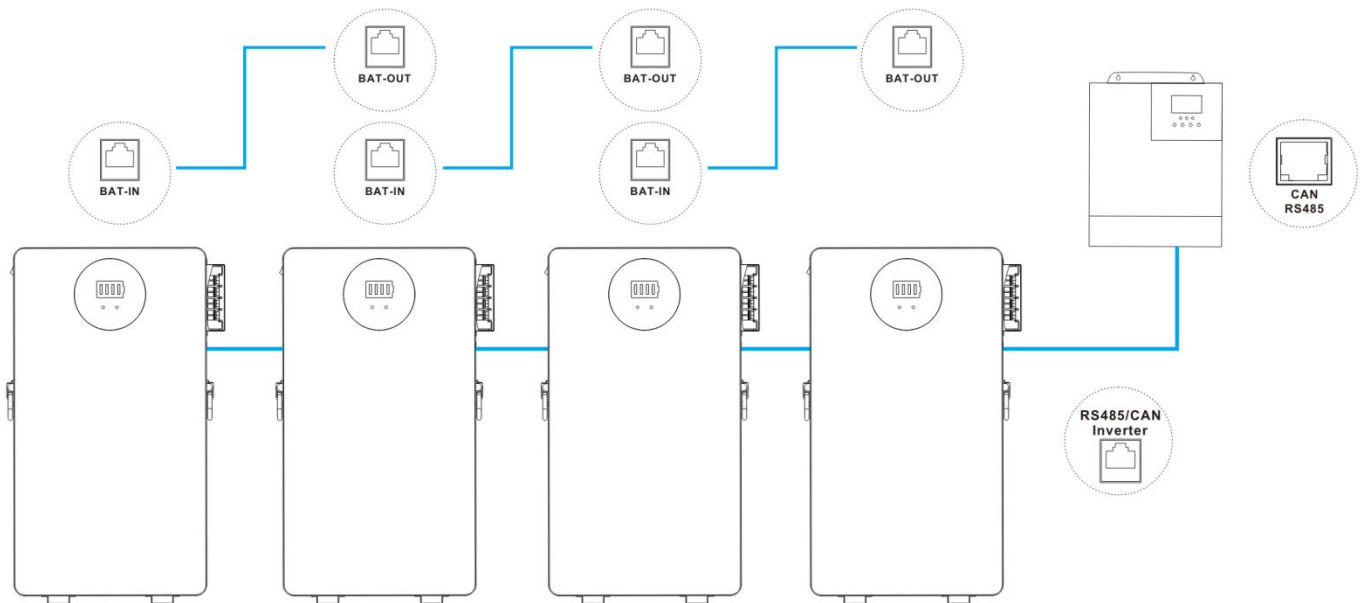

7 System Debugging

7.1 Inspections Before Power-On

No.	Inspection items	Acceptance criteria	Validation
1	The energy storage is installed in place	The installation is correct, secure and reliable.	<input type="checkbox"/> Yes <input type="checkbox"/> No
2	The installation environment meets requirements	The installation space is reasonable and the environment is clean and tidy without any construction	<input type="checkbox"/> Yes <input type="checkbox"/> No
3	The power cord is correctly connected	The positive and negative terminals are connected correctly without any missing.	<input type="checkbox"/> Yes <input type="checkbox"/> No
4	The signal line is correctly connected	The signal line is connected reliably, and there is no wrong position	<input type="checkbox"/> Yes <input type="checkbox"/> No
5	The grounding is reliable	The grounding wire is correctly and reliably connected.	<input type="checkbox"/> Yes <input type="checkbox"/> No
6	The switch of the energy storage battery module is off	All switches connected to the energy storage are in the "OFF" state.	<input type="checkbox"/> Yes <input type="checkbox"/> No

7.2 Power-On of Battery Module

7.2.1 Power-up Sequence

Once the batteries are connected to the inverter, power up in the following sequence.

Firstly, switch on the circuit breaker switch

Second, turn on the battery switch button and the battery starts to work.

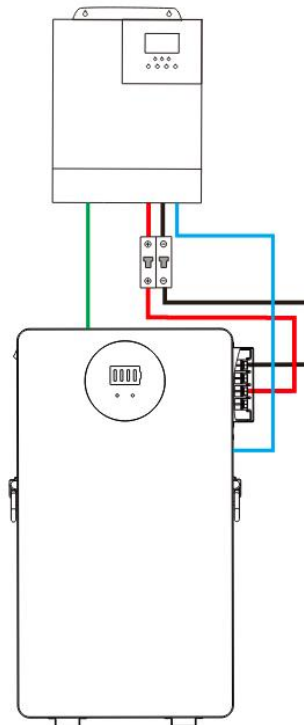



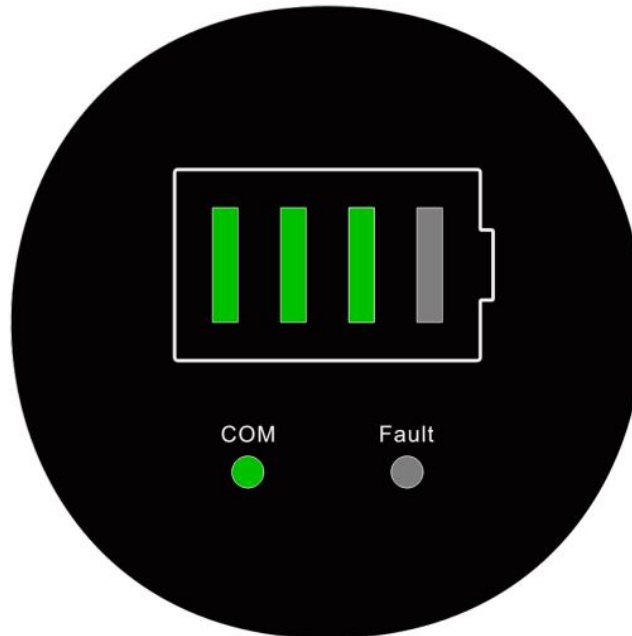

7.2.2 System Status Indication

After the battery switch button is turned on, the LED indicator will light up or flash. The meaning of the LED indicator is as follows.



System Status	Events	COM	FAULT
POWER OFF	Power Off	OFF	OFF
Steady	Normal	Flash(GREEN LED)	OFF
	Alarm		Flash
Charging	Normal		OFF
	Alarm		Flash
	Over Charge Protection		OFF
	High temperature, Over Current		ON
Discharging	Normal	Flash(GREEN LED)	OFF
	Alarm		Flash
	Over Discharge Protection		OFF
	Over Current , Short Current		ON
WiFi/Bluetooth	Communicating	Flash(BULE LED)	
	No communication	OFF	

7.2.3 Capacity indicator

Capacity indicator LED	SOC
	0 ~ 25%
	25 ~ 50%
	50 ~ 75%
	75 ~ 100%

7.3 Battery Communication Protocol

The supported inverter and battery manufacturer communication protocols are as follows, and will be continuously updated.

Battery /Inverter brand	CAN protocol	485 protocol
Pylon	√	√
Growatt	√	√
Victron	√	
Goodwe	√	
Solis	√	
Luxpower	√	
Sofar	√	
KStar	√	
SMA	√	
MEGAREVO	√	
Afore	√	
SRNE		√
Deye		√
Voltronic		√
Paceic		√

7.4 Bluetooth Function

7.4.1 Download App

Scan the QR code to download the APP.



7.4.2 Add Device

Connecting the device requires turning on Bluetooth, and location permissions.

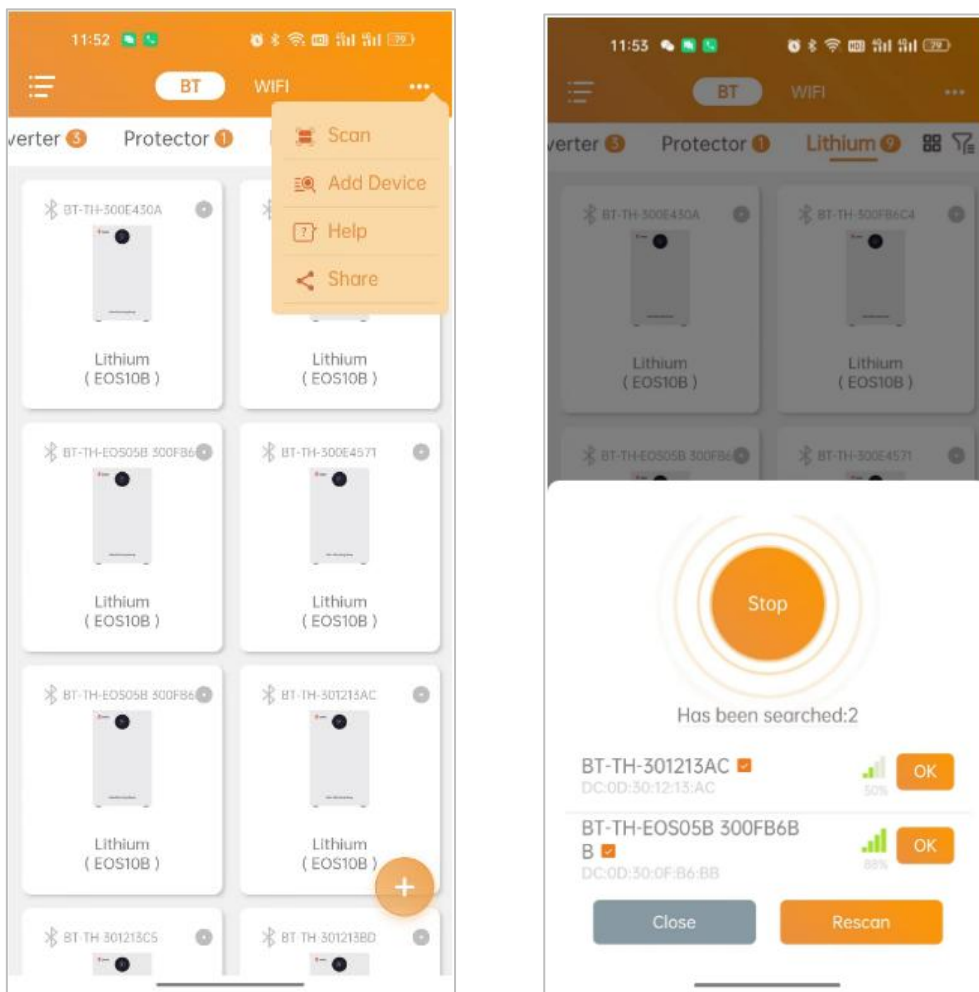

7.5 Tuya WiFi Function (Optional)

7.5.1 Download App

Scan the QR code to download the APP.



7.5.2 Register and Login

You need to register an account for the first time.

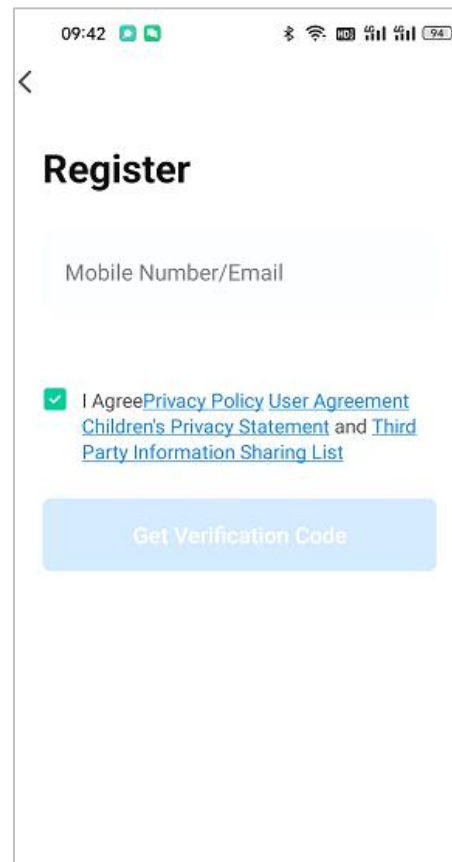
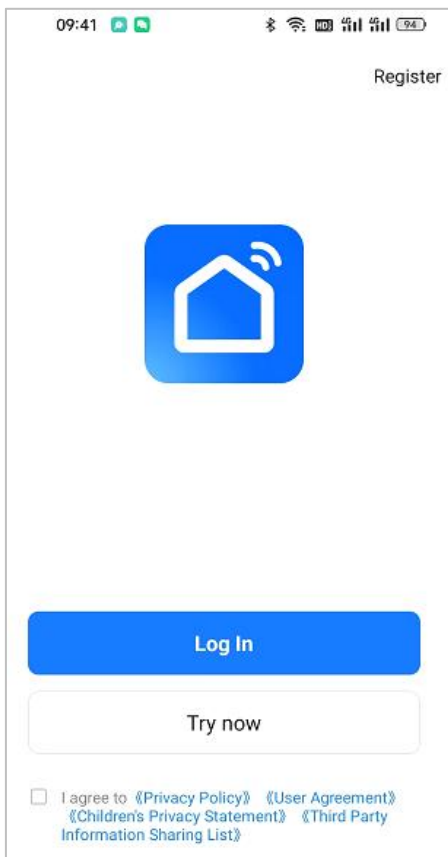

7.5.3 Add Device

Connecting the device requires turning on Bluetooth, WIFI, and location permissions.

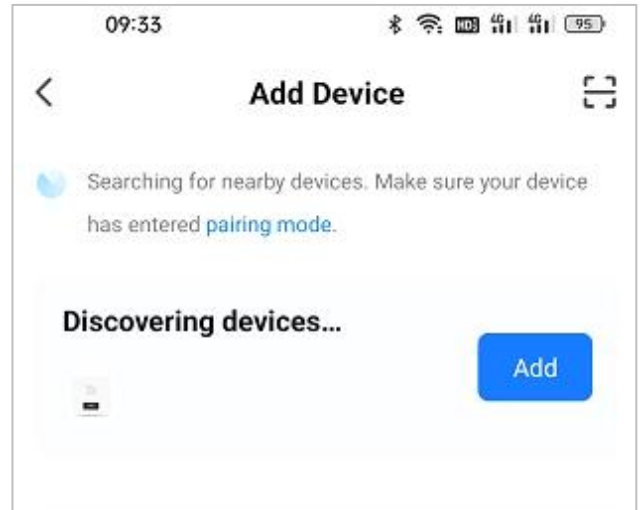
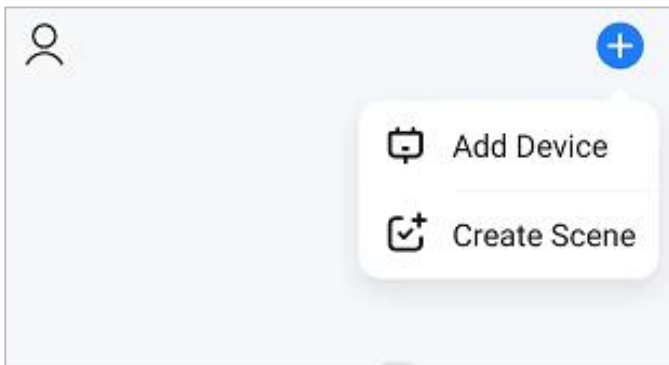

7.5.4 Connect Network

Choose WIFI and enter the password, the device starts connecting to the network.

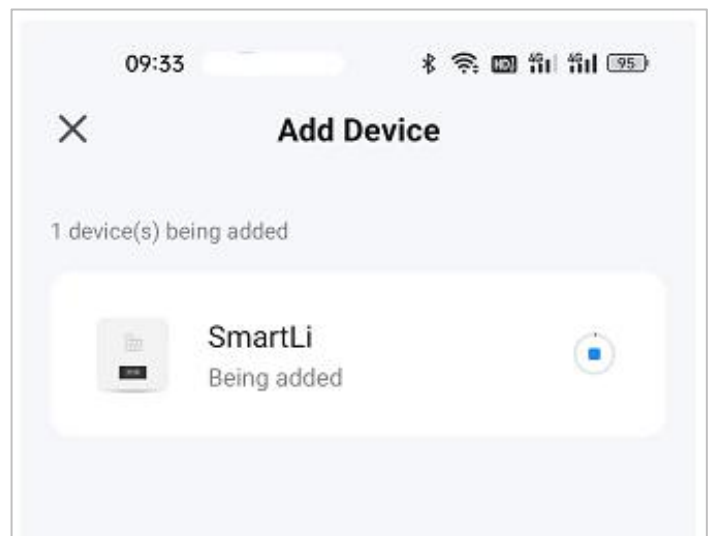
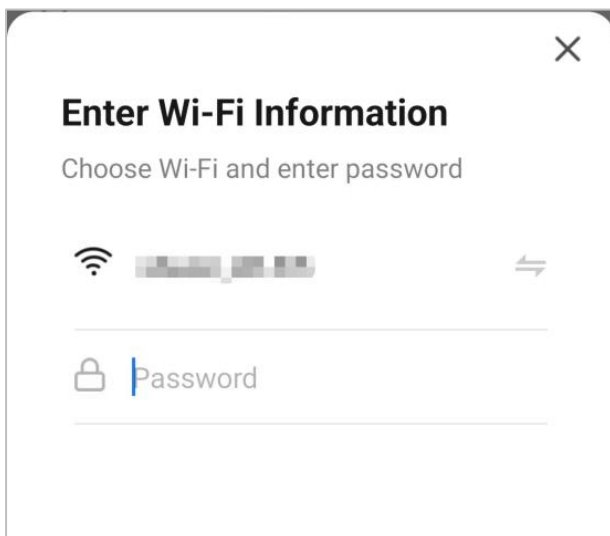

7.5.5 Reset WIFI

If you can't connect to the network or need to change the network environment, please reset the WIFI.



Only supports 2.4G band's WiFi , not supports 5G band's WiFi , please make sure that the 2.4G band of the router is turned on.

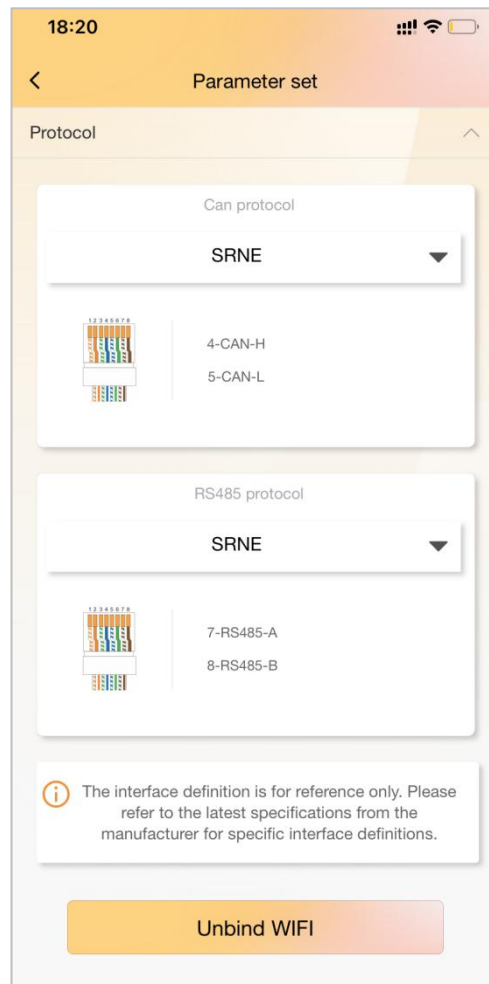

7.6 Sleep Mode

If the battery is neither charged nor discharged, it will automatically enter sleep mode after a period of time. After entering sleep mode, BMS will turn off LED and WiFi module to save power. If you want to continue using it, please turn the power button on and off again.

8 System Maintenance

8.1 System Power-Off



After the system is powered off, the case still has residual power and heat, which may cause electric shocks or burns. Therefore, protective gloves should be worn before operating the energy storage 5 minutes after the system is powered off. Maintenance operations on energy storage should be performed only after ensuring that all indicator lights of the energy storage are off.

Power-off operation steps of the system:

Step 1 Turn off the breaker switch between the inverter and AC output (If installed).

Step 2 Turn off the breaker switch between the inverter unit and AC input (If installed).

Step 3 Turn off the breaker switch between the inverter unit and the PV string (If installed).

Step 4 Turn off the breaker switch between the inverter and battery.

Step 5 Turn off button on all storage battery modules, the energy storage is powered off successfully.

8.2 Routine Maintenance

To ensure the long-term and good operation of the energy storage system, it is recommended to perform the routine maintenance as described in this section.

Items	Methods	Maintenance interval
System cleanliness	Check if the radiator is covered or dirt on a regular basis.	Once every six months to one year.
Running status of system	<ul style="list-style-type: none"> Observe whether the energy storage appearance is damaged or deformed. Listen to whether the energy storage has any abnormal sound during running. When the energy storage is running, check whether the indicator of the energy storage battery is correct. 	Once every six months.
Electrical connection	<ul style="list-style-type: none"> Check if any cable connection is off or loose. Check if any cable is damaged, and especially if there are cuts on the sheath where the cable contacts with the metal surface. Check if the unused DC input terminals, energy storage terminals, COM ports, and covers are locked. 	Half a year after first debugging and testing, and once every six months to one year thereafter.
Grounding reliability	Check if the grounding cable is grounded reliably.	Half a year after first debugging and testing, and once every six months to one year thereafter.

8.3 Common Faults and Handling Methods

Faults	Handling measures
The indicator light and LCD does not work	Check whether battery is sleeping mode.If the battery is neither charged nor discharged, it will automatically enter sleep mode after a period of time.
All indicators of the battery are off	If the battery power is low, you need to charge it before using it. If the battery is not used for a long time, it will automatically sleep, and it can be used normally after restarting.
Battery overcurrent protection fault	Check whether there is a short circuit in the battery wiring. Check whether the load power exceeds the maximum
The battery cannot be charged	Check if the battery is fully charged Check whether the ambient temperature is below -10 degrees.
Communication error with inverter	Check whether the communication interface is incorrectly plugged in and Whether the wiring is secure. Whether the battery address is set correctly. Whether the protocol is secure.
WiFi communication error	Check if the router settings are correct Check whether the routing network is normal Check whether the router's 2.4G frequency band is turned on

8.4 Battery Storage and Maintenance

8.4.1 Battery Storage Requirements



Do not put the battery into fire. The battery may explode.

Do not open or damage the battery. The electrolyte flowing out from the battery is harmful to the skin and eyes. The electrolyte may also be toxic;

1. When being stored, the batteries shall be placed correctly in accordance with the marks on the packing case. Do not put them upside down or on the side.
2. When stacking up the battery packing cases, the stacking requirements on the outer package shall be met.
3. The batteries should be handled with care, and damage to batteries should be strictly prohibited.
4. Requirements for the storage environment:
 - Ambient temperature: -10°C to 55°C, recommended storage temperature: 20°C to 30°C.
 - Relative humidity: 5%RH-80%RH.
 - Dry, well ventilated, and clean.
 - The corrosive organic solvents, gases and other substances shall be kept away.
 - Exposing to direct sunlight shall be avoided.
 - The distance from the heat source should not be less than two meters.

5. When being stored, the battery shall be disconnected from the external connection. If there is an indicator light on the battery panel, the indicator light shall be off.
6. When the stored batteries are going to be delivered, the first-in first-out principle should be followed.
7. After the battery is produced and tested, it shall be recharged to at least 50% SOC before being stored. If the device will not be used for a long period of time, discharge the battery to 45% to 60% of the battery capacity and disconnect the battery output to avoid the battery runs out;
8. Do not touch the battery pack with wet hands.
9. Do not squeeze, drop, or pierce the battery.
10. The battery should always be disposed in accordance with local safety regulations.
11. The battery should be stored and recharged in accordance with this User's Manual.
12. Do not reverse polarity of the battery when storing or transporting the batteries, the batteries shall not be stacked up without protective packaging, and the number of stacked packed batteries should not exceed the number specified on the packaging.
13. All operators of the energy storage system shall comply with the user manual, installation and service manual, and quality assurance requirements. Any damage to the device resulting from neglecting or misreading of the user's manual, installation and service manual, and the quality assurance requirements will invalidate the product warranty.

8.4.2 Requirements for Charging of Battery

The batteries to be stored for a long period of time (unused, for more than 3 months) must be kept in a dry and cool place. The storage voltage is 51V~53V. The batteries should be stored in a clean environment of $23\pm 2^{\circ}\text{C}$ and humidity of 45%~75%. If the battery will be shelved and not used for a long period of time, it should be recharged every 3 months to ensure that the battery voltage is within the above range.

As for batteries and long-term storage, routine maintenance is required. Please charge the battery to 40% SOC at a current of 0.2C according to the requirements in the table below.

Ambient temperature for storage	Relative humidity for storage environment	Storage Time	SOC
<-10°C	/	Prohibited	/
-10~25°C	5%~70%	≤12 months	30%≤SOC≤60%
25~35°C		≤6 months	
35~45°C		≤3 months	
>45°C	/	Prohibited	/

8.5 Device Cleaning

It is recommended to clean and maintain the product from time to time. When cleaning, the dust and stains on the product shall be removed with a piece of soft dry cloth or vacuum cleaner. The product shall not be cleaned with organic solvents, corrosive liquids and other cleaning products.

9 Product Dimensions and Packaging

9.1 Product Dimensions

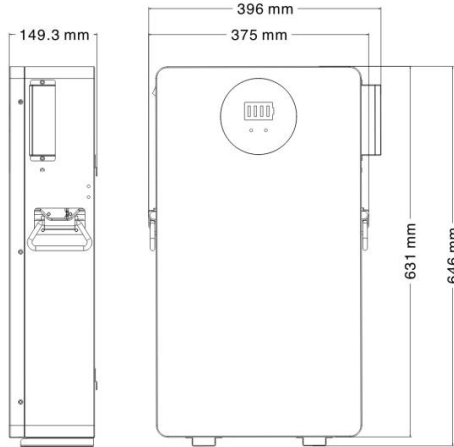

SR-SE05S is 646*396*149.3mm.

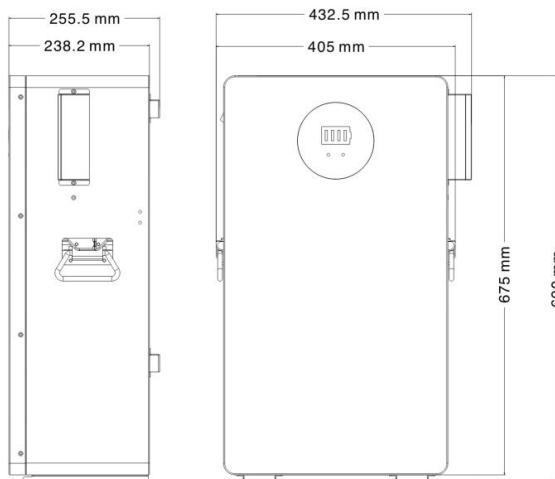

SR-SE10S is 690*432.5*255.5mm.

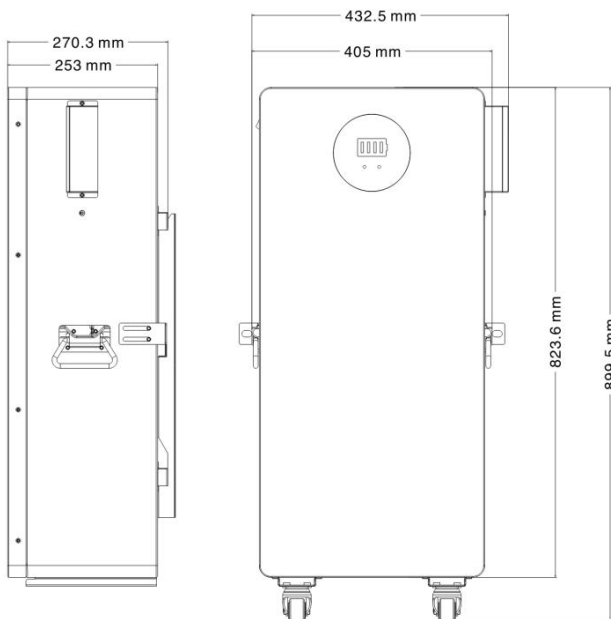

SR-SE15S is 899.5*432.5*270.3mm.

9.2 Package Dimensions

A single energy storage battery module , The packaging size of SE05B is 695*470*200mm.

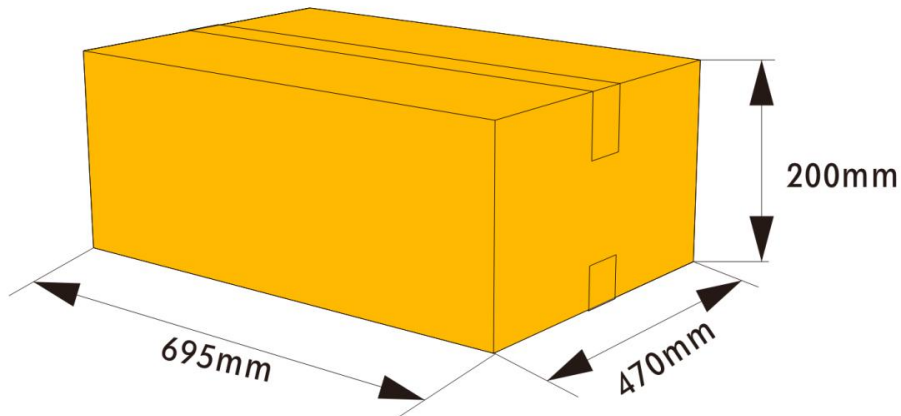

A single energy storage battery module , The packaging size of SE10B is 740*535*305mm.

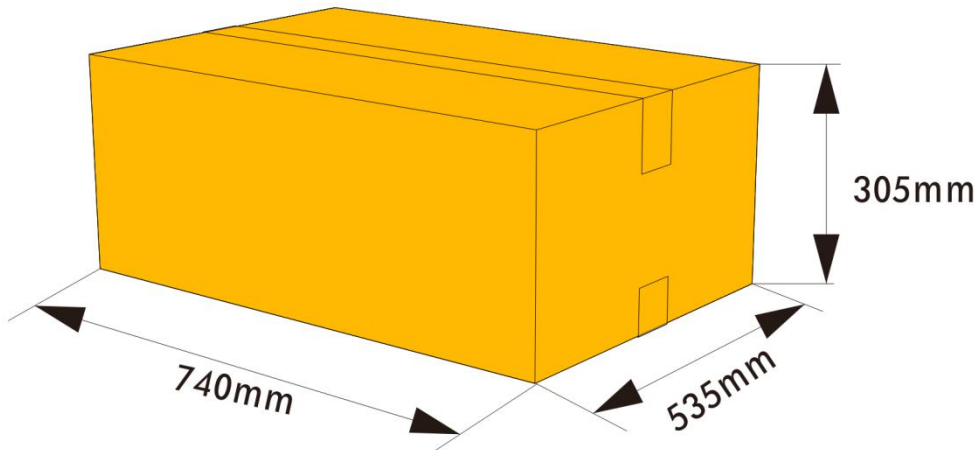

A single energy storage battery module , The packaging size of SE15B is 940*450*323mm.

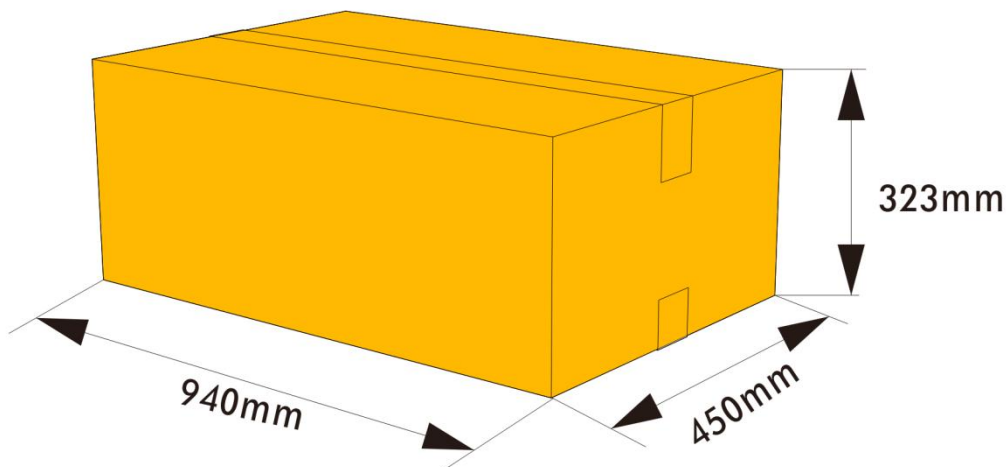

9.3 Accessories

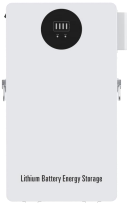
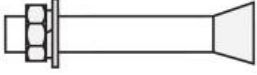
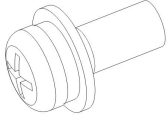
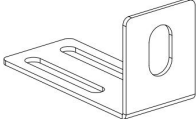
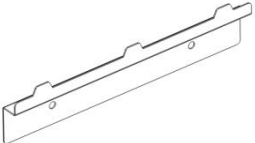
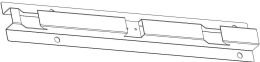
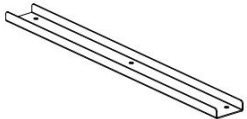
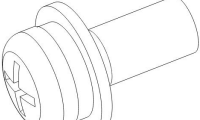
NO.	Picture	materials	Quantity	Remark
1		Battery Pack	1	5.12kWh/10.49kWh/14.33kWh
2		Mounting Frame Screw	8	M8*60 expansion bolt
3		Screw/Wrie	4	PM5*12mm
4		Side fastener	2	80*44*36mm
5		Side fastener (only for SE05B)	2	340*75.2*23mm
6		Mounting Frame (only for SE10/15B)	3	510.42*85.8*30mm
7		Mounting Frame Connecting Strip (only for SE10/15B)	1	375*39*12mm
8		Screw/Wrie (only for SE10/15B)	7	PM4*10mm

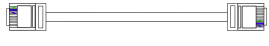
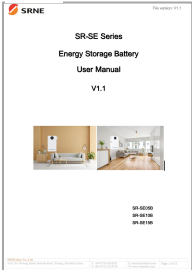
9		Power Cable	2	Standard
10		Signal cable	1	Standard
7		User Manual	1	Standard